

FRED Ultrafast Soft Recovery Diode, 60A

Features:

- Ultrafast Recovery
- 175°C operating junction temperature
- High frequency operation
- Low power loss, less RFI and EMI
- Low I_R value
- High surge capacity
- Epitaxial chip construction

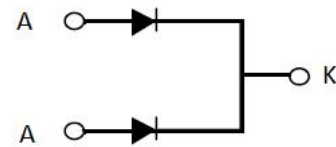
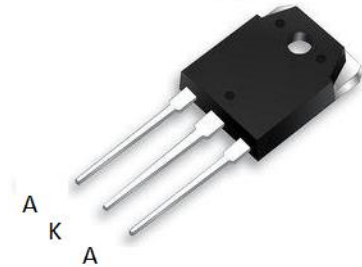

Product Summary	
V_R	600 V
$I_{F(AV)}$	2*30A
t_{rr}	28 ns

Description/Applications

These diodes are optimized to less losses and EMI/RFI in high frequency power conditioning system. The soft recovery behavior of the diodes offers the need as snubber in most applications. These devices are ideally suited for HF welding power converters and other applications where the switching losses are not significant portion of the total losses.

Absolute Maximum Ratings				
Parameter	Symbol	Test Conditions	Values	Units
Repetitive peak reverse voltage	V_{RRM}		600	V
Continuous forward current	$I_{F(AV)}$	$T_c = 110^\circ\text{C}$	60	A
Single pulse forward current	I_{FSM}	$T_c = 25^\circ\text{C}$	480	
Maximum repetitive forward current	I_{FRM}	Square wave, 20kHz	110	
Operating junction	T_j		175	$^\circ\text{C}$
Storage temperatures	T_{stg}		-55 to +175	$^\circ\text{C}$

Electrical characteristics (Ta=25°C unless otherwise specified)						
Parameter	Symbol	Test Conditions	Min	Typ.	Max.	Units
Breakdown voltage Blocking voltage	V_{BR} , V_R	$I_R=100\mu A$	600			V
Forward voltage (Per Diode)	V_F	$I_F=30A$		1.30	1.60	
		$I_F=30A, T_j=125^\circ C$		1.05	1.40	
Reverse leakage current(Per Diode)	I_R	$V_R=V_{RRM}$			20	μA
		$T_j=150^\circ C, V_R=600V$			200	
Reverse recovery time(Per Diode)	t_{rr}	$I_F=0.5A, I_R=1A, I_{RR}=0.25A$		35	45	ns
		$I_F=1A, V_R=30V, di/dt=200A/\mu s$		28	35	

Thermal characteristics

Paramter	Symbol	Typ	Units
Junction-to-Case	$R_{\theta JC}$	0.8	$^\circ C/W$

Electrical performance (typic)

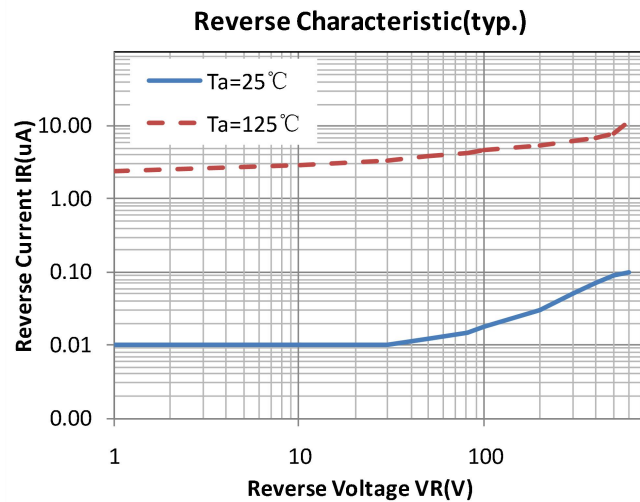
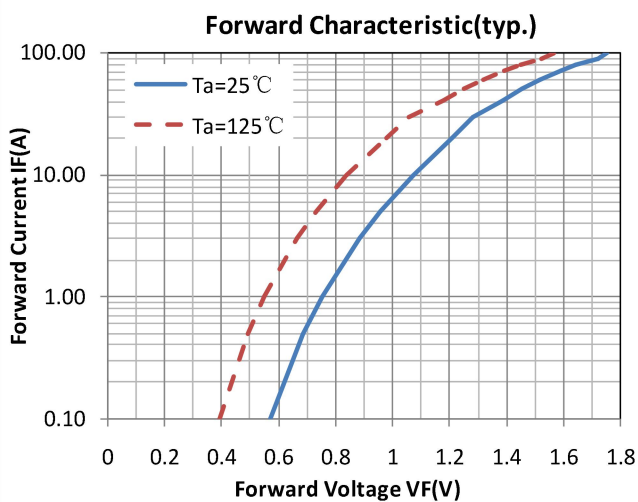

Package Information

TO-3PB PACKAGE

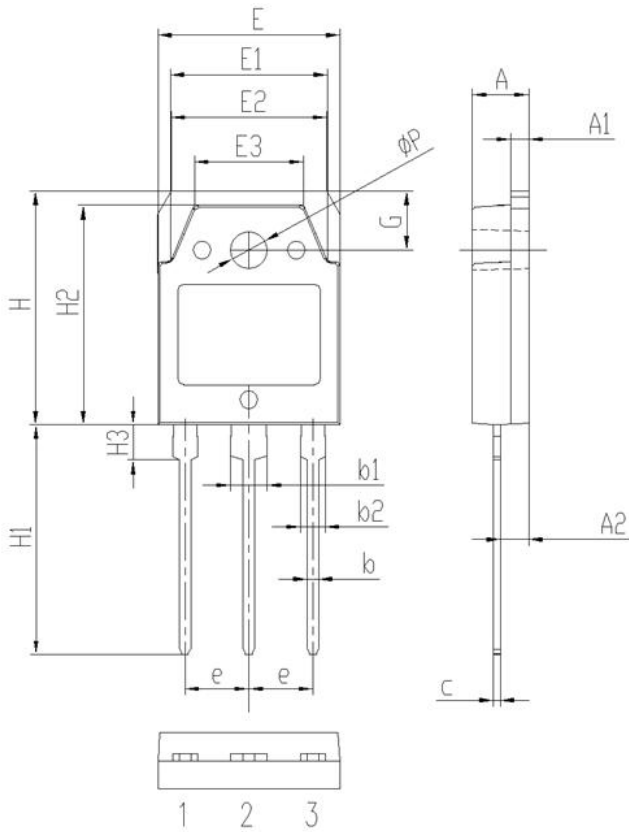

Symbol	Dimensions(millimeters)	
	Min.	Max.
A	4.60	5.00
A1	1.30	1.70
A2	2.20	2.60
b	0.80	1.20
b1	2.90	3.30
b2	1.90	2.30
c	0.40	0.80
e	5.25	5.65
E	15.3	15.7
E1	13.2	13.6
E2	13.1	13.5
E3	9.10	9.50
H	19.7	20.1
H1	19.1	20.1
H2	18.3	18.7
H3	2.80	3.20
G	4.80	5.20
ΦP	3.00	3.40