



HMM15R120NC2

Silicon Carbide MOSFET Power Module
N-CHANNEL ENHANCEMENT MODE

Features

- Low Conduction and Switching Loss
- Zero Reverse Recovery
- Temperature Independent Switching Behavior
- Positive Temperature Coefficient Device
- High Surge Current Capability
- RoHS Compliant and Halogen Free

Benefits

- Higher System Efficiency
- Increase Parallel Device Convenience
- Temperature Independent Switching Behavior
- Allow High Frequency Operation
- Realize Compact and Lightweight Systems

Applications

- Switching Mode Power Supply
- PFC
- UPS
- Motor Drives
- Flywheel diode in Power Inverters
- Solar/Wind Renewable Energy

Product Summary

V_{DS}	1200V
$I_D(@25^\circ C)$	156A*
$R_{DS(on)}$	15mΩ

Circuit Diagram

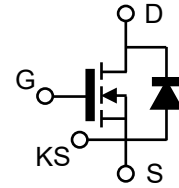

Description

The HMM15R120NC2 1200V, 15m Ω silicon carbide power MOSFET is an N-channel enhancement mode device. Exploiting the outstanding wide bandgap material properties, this device shows high current density and great switching behavior. Thanks for the excellent thermal conductivity and many advantages of SiC, this device significantly improved in thermal capability and temperature independent switching behavior.

Absolute Maximum Ratings ($T_c = 25^\circ C$ unless otherwise specified)

Parameter	Symbol	Test Conditions	Value	Unit
Drain – Source Voltage	$V_{DS,max}$	$V_{GS}=0V, I_{DS}=200\mu A$	1200	V
Continuous Drain Current	I_D	$V_{GS}=20V, T_c=25^\circ C$	156*	A
		$V_{GS}=20V, T_c=110^\circ C$	107*	
Pulse Drain Current	$I_{D,pulse}$	t_{PW} limitation per Fig.15	600*	
Avalanche energy, Single Pulse	E_{AS}	$V_{DD}=100V, I_D=20A$	5000*	mJ
Power Dissipation	P_D	$T_c=25^\circ C$	750*	W
Recommend Gate Source Voltage	$V_{GS,op}$	Static, recommended DC operating values	-5 to 20	V
Maximum Gate Source Voltage	$V_{GS,max}$	Transient operating limit (AC f > 1Hz, duty cycle < 1%)	-10 to 25	
Junction & Storage Temperature	T_j, T_{stg}		-55 to 175	$^\circ C$
Soldering Temperature	T_L		260	



Electrical Characteristics (T_c = 25°C unless otherwise specified)

Parameter	Symbol	Test Conditions	Min.	Typ.	Max.	Unit
Drain-Source Breakdown Voltage	V _{(BR)DSS}	V _{GS} =0V, I _{DS} =200μA	1200			V
Gate Threshold Voltage	V _{GS(th)}	V _{DS} =10V, I _{DS} =100mA		3.2		V
Zero Gate Voltage Drain Current	I _{DSS}	V _{DS} =1200V, V _{GS} =0V		<1	100	μA
		V _{DS} =1200V, V _{GS} =0V T _j =175°C		20	1000	
Gate-Source Leakage Current	I _{GSS}	V _{GS} =20V, V _{DS} =0V			250	nA
Drain-Source On-State Resistance	R _{DS(on)}	V _{GS} =20V, I _{DS} =80A		15	20	mΩ
		V _{GS} =20V, I _{DS} =80A, T _j =175°C		27		
Transconductance	g _{fs}	V _{DS} =15V, I _{DS} =80A		34		S
Input Capacitance	C _{iss}	V _{GS} =0V, V _{DS} =800V f=1MHz, V _{AC} =25mV		9818*		pF
Output Capacitance	C _{oss}			396*		
Reverse Transfer Capacitance	C _{rss}			68*		
Effective Output Capacitance, Energy Related	C _{o(er)}	V _{GS} =0V, V _{DS} =0 to 800V		514*		pF
Effective Output Capacitance, Time Related	C _{o(tr)}	I _D =const., V _{GS} =0V, V _{DS} =0 to 800V		718*		
Turn On Delay Time	t _{d(on)}	V _{DS} =800V, V _{GS} =-4/+20V, I _D =80A, R _L =10Ω, R _{G(ext)} =1.4 Ω		46*		ns
Rise Time	t _r			70*		
Turn Off Delay Time	t _{d(off)}			23*		
Fall Time	t _f			27*		
C _{oss} Stored Energy	E _{oss}	V _{GS} =0V, V _{DS} =800V f=1MHz, V _{AC} =25mV		161*		μJ
Turn-on Switching Energy	E _{on}	V _{DS} =800V, V _{GS} =0/20V, I _D =80A,		353**		
Turn-off Switching Energy	E _{off}	R _{G(ext)} =1.4 Ω		541**		
Internal Gate Resistance	R _{G(int.)}	f=1MHz, V _{AC} =25mV		0.4		Ω

*By estimation

**Based on the results of calculation, note that the energy loss caused by the reverse recovery of free-wheeling diode is not included in E_{on}.

Built-in SiC Diode Characteristics (T_c = 25°C unless otherwise specified)

Parameter	Symbol	Test Conditions	Typ.	Unit
Inverse Diode Forward Voltage	V _{SD}	V _{GS} =0V, I _{SD} =20A	3.0	V
Continuous Diode Forward Current	I _S	V _{GS} =0V, T _c =25°C	114*	A
Reverse Recovery Time	t _{rr}	V _{GS} =0V, I _{SD} =30A, V _{DS} =400V, di/dt=300A/μs	160*	ns
Reverse Recovery Charge	Q _{rr}		568*	nC
Peak Reverse Recovery Current	I _{rrm}		14*	A

Gate Charge Characteristics (T_c = 25°C unless otherwise specified)

Parameter	Symbol	Test Conditions	Value	Unit
Gate to Source Charge	Q _{GS}	V _{DS} =800V, V _{GS} =-5/+20V, I _D =80A	182	nC
Gate to Drain Charge	Q _{GD}		176	
Total Gate Charge	Q _G		610	
Gate plateau voltage	V _{pl}		7.9	V



Thermal Characteristics

Parameter	Symbol	Test Conditions	Value	Unit
Max. MOSFET Junction Temperature	T_{Jmax_MOS}		175	°C
Max. Diode Junction Temperature	T_{Jmax_Di}		175	
Operating Temperature	T_{Jop}		-55~175	
Storage Temperature	T_{stg}		-55~175	
Thermal Resistance, Junction to Case	$R_{th(j-c)}$	JESD51-14	0.2*	°C/W

*By estimated

Mechanical Characteristics

Parameter	Symbol	Test Conditions	Value	Unit
Isolation Breakdown Voltage	V_{iso}	AC, 50Hz (R.M.S), t=1minute	2500	V
Comparative Tracking Index	CTI		TBD	
Terminal connection Torque	τ_{tc}	Recommended (M4 screw)	1.3	Nm
Weight	W		30	g



Typical Device Performance

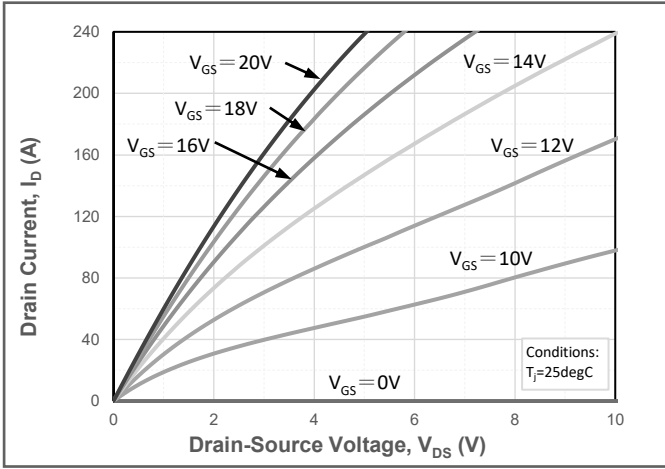

Fig.1 Forward Output Characteristics at $T_j = 25^\circ\text{C}$

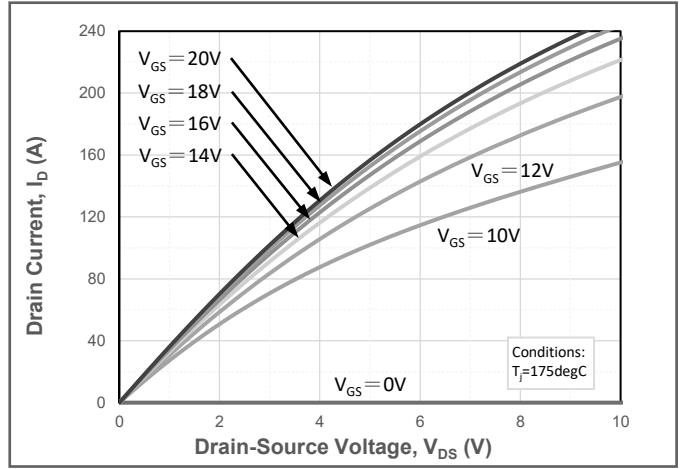

Fig.2 Forward Output Characteristics at $T_j = 175^\circ\text{C}$

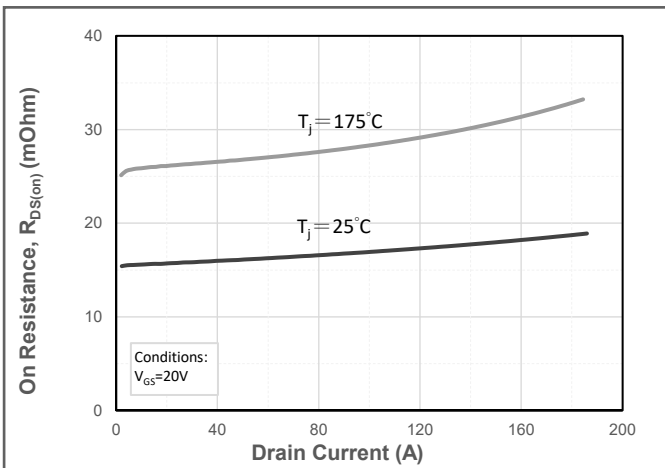

Fig.3 On-Resistance vs. Drain Current for Various T_j

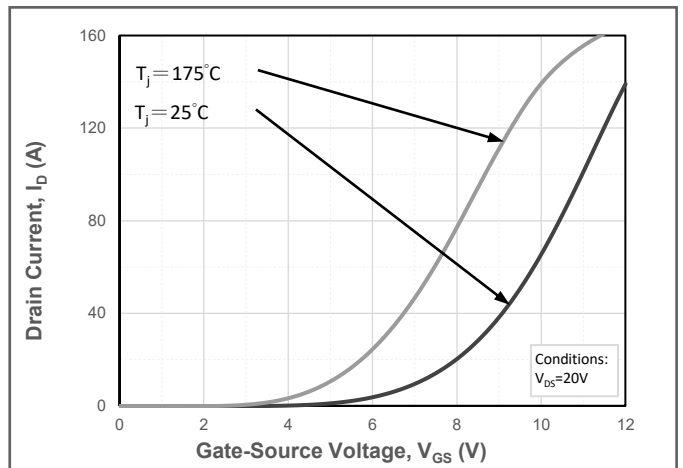

Fig.4 Transfer Characteristics for Various T_j

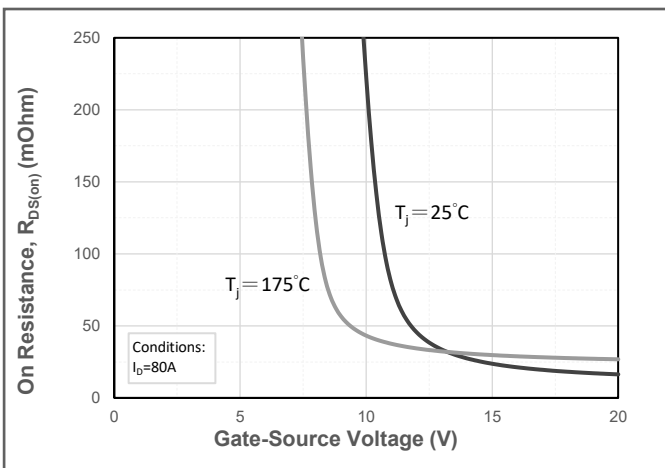

Fig.5 On-Resistance vs. Gate Voltage for Various T_j

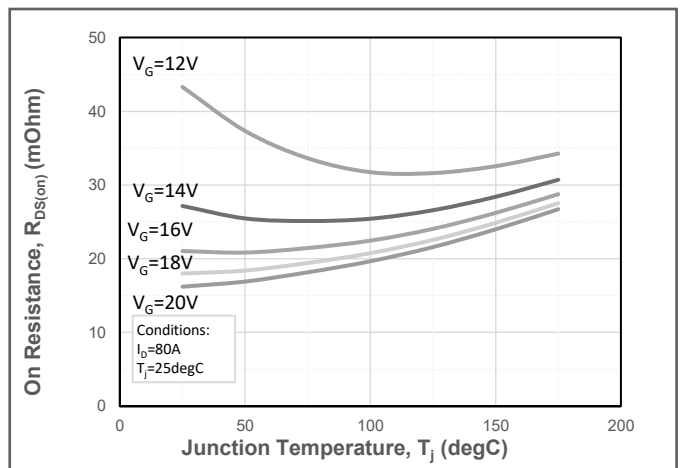

Fig.6 On-Resistance vs. Temperature for Various Gate Voltage



Typical Device Performance

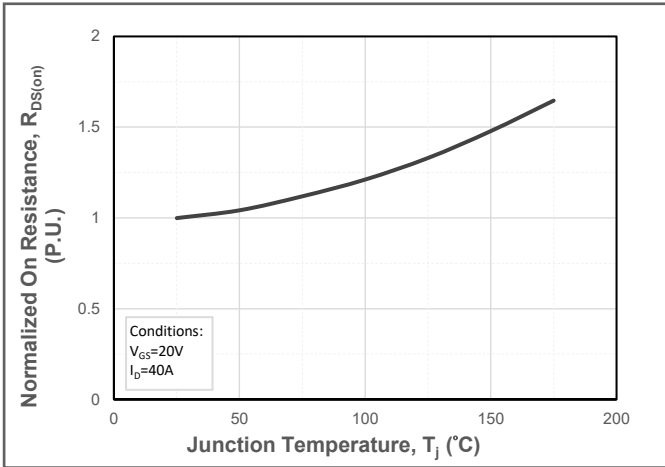

Fig.7 Normalized On-Resistance vs. Temperature

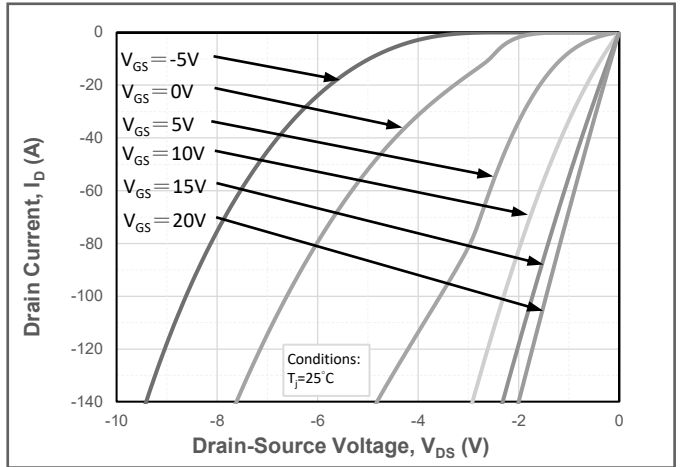

Fig.8 Reverse Output Characteristics at $T_j = 25^\circ C$

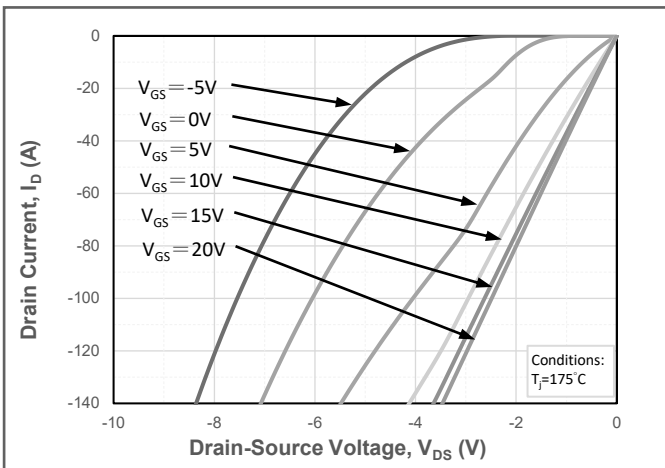

Fig.9 Reverse Output Characteristics at $T_j = 175^\circ C$

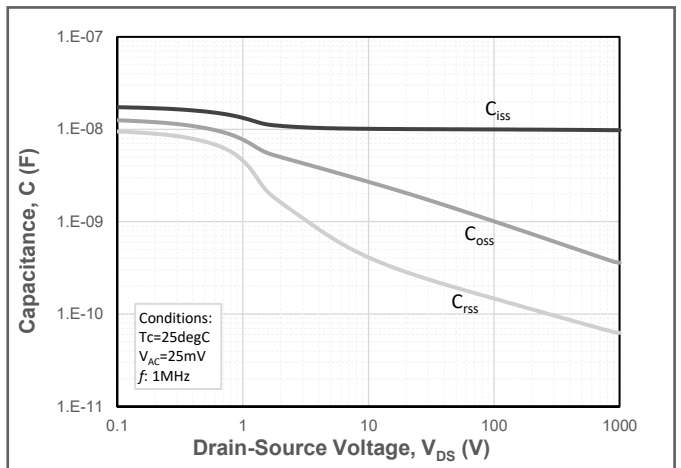

Fig.10 Capacitances vs. Drain to Source Voltage

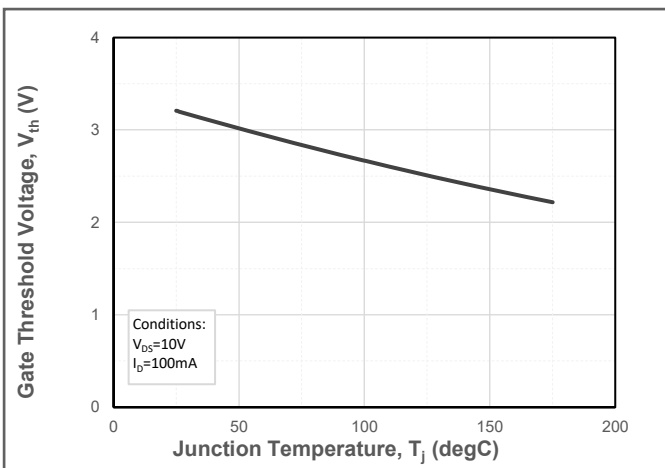

Fig.11 Threshold Voltage vs. Temperature

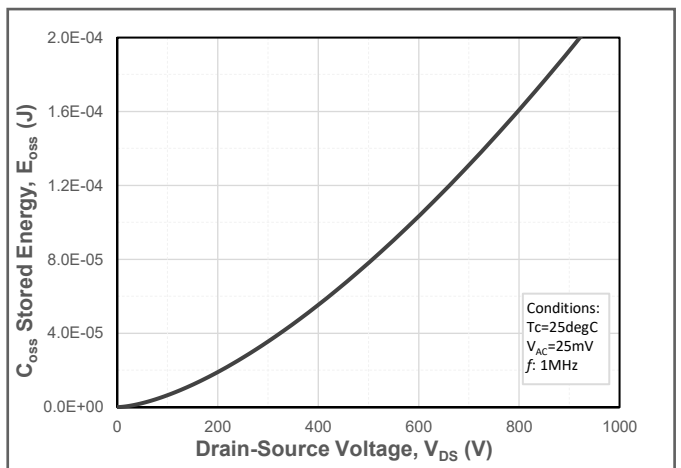

Fig.12 Output Capacitor Stored Energy



Typical Device Performance

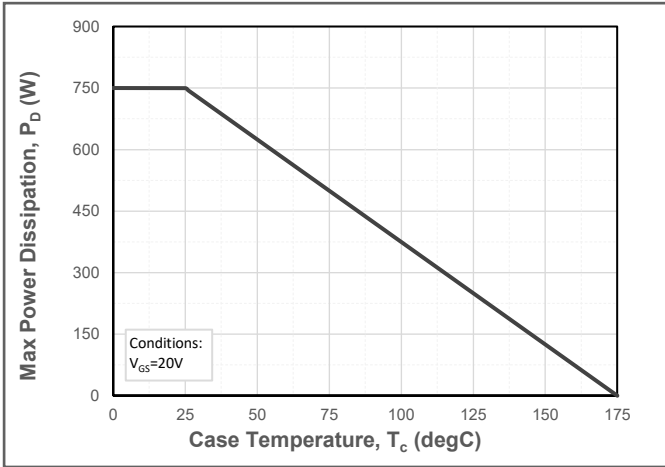

Fig.13 Maximum Power Dissipation Derating vs. Case Temperature

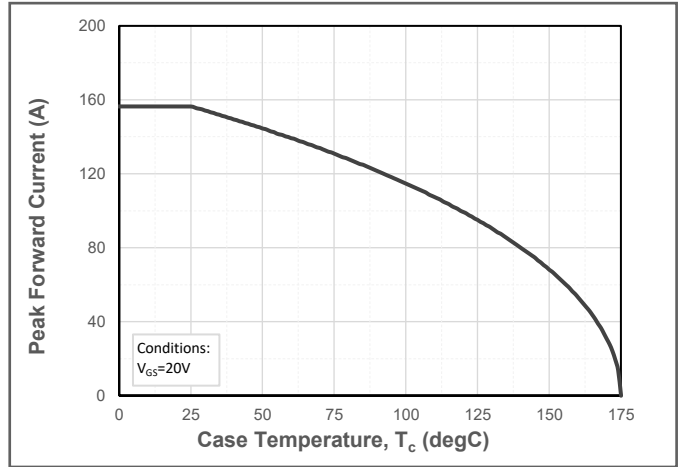

Fig.14 Drain Current Derating vs. Case Temperature

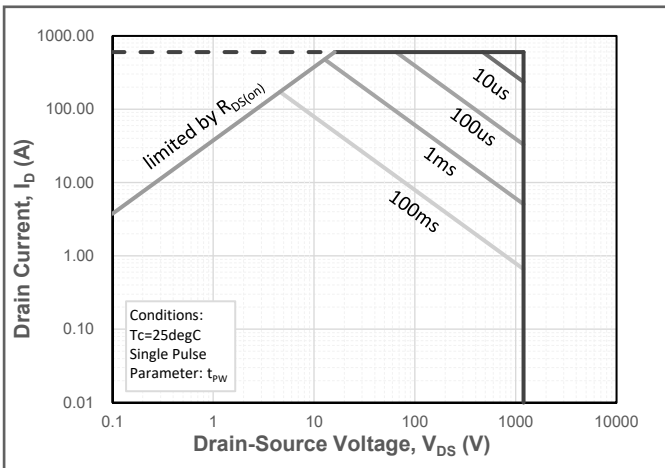

Fig.15 Safe Operating Area

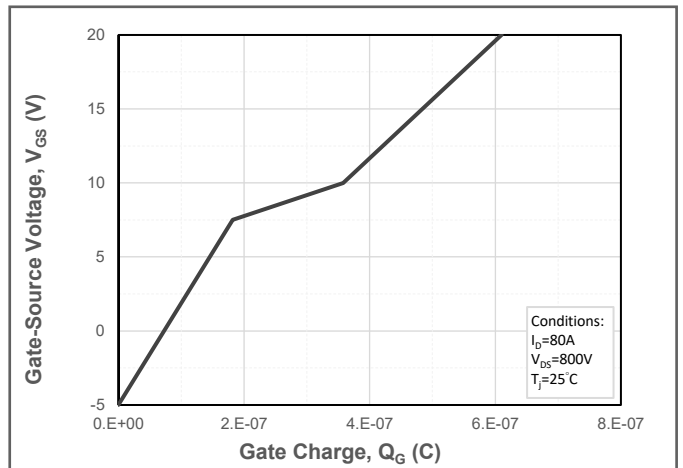

Fig.16 Gate Charge Characteristics

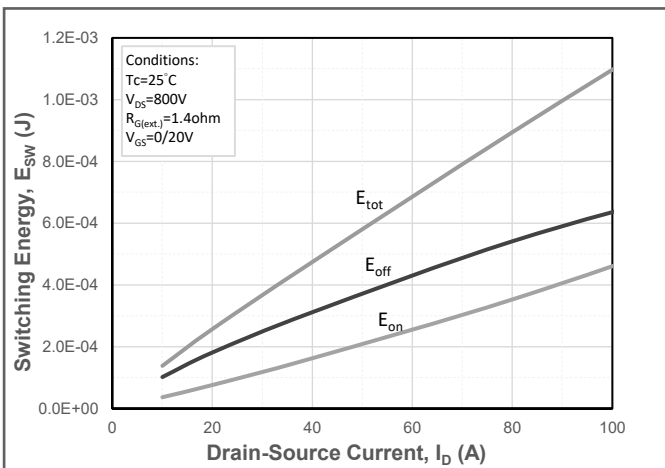

Fig.17 Clamped Inductive Switching Energy vs. Drain-Source Current, I_D (A)

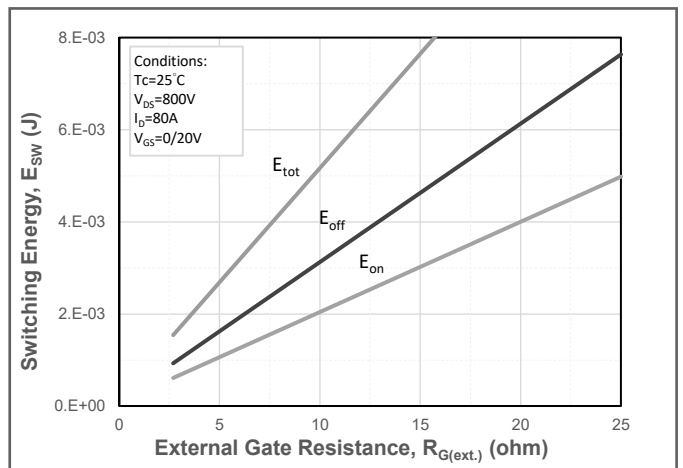

Fig.18 Clamped Inductive Switching Energy vs. External Gate Resistor ($R_{G(ext.)}$)



Typical Device Performance

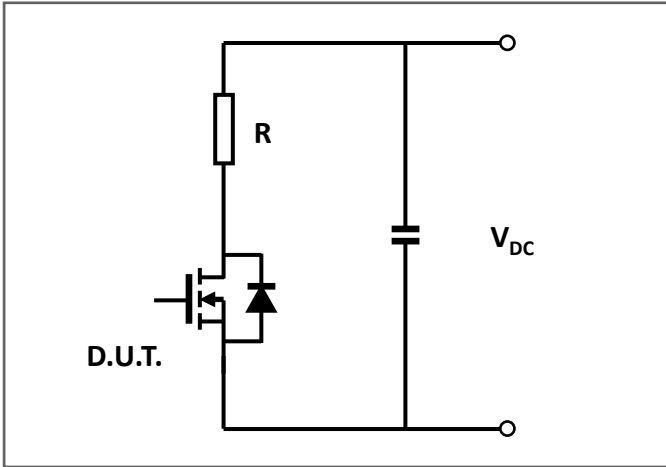

Fig.19 Schematic of Resistive Switching

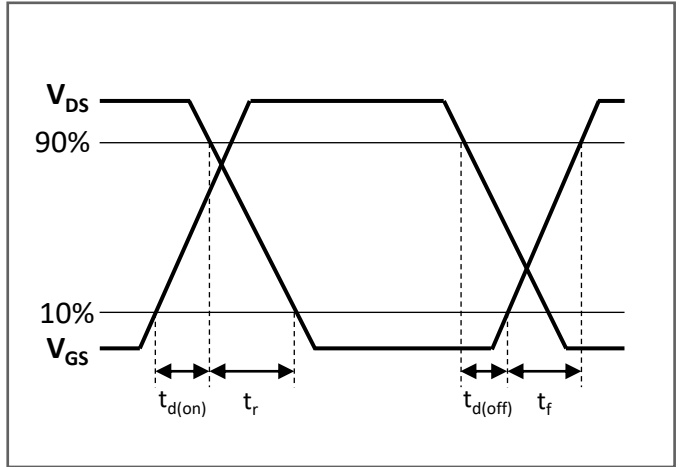

Fig.20 Switching Times Definition

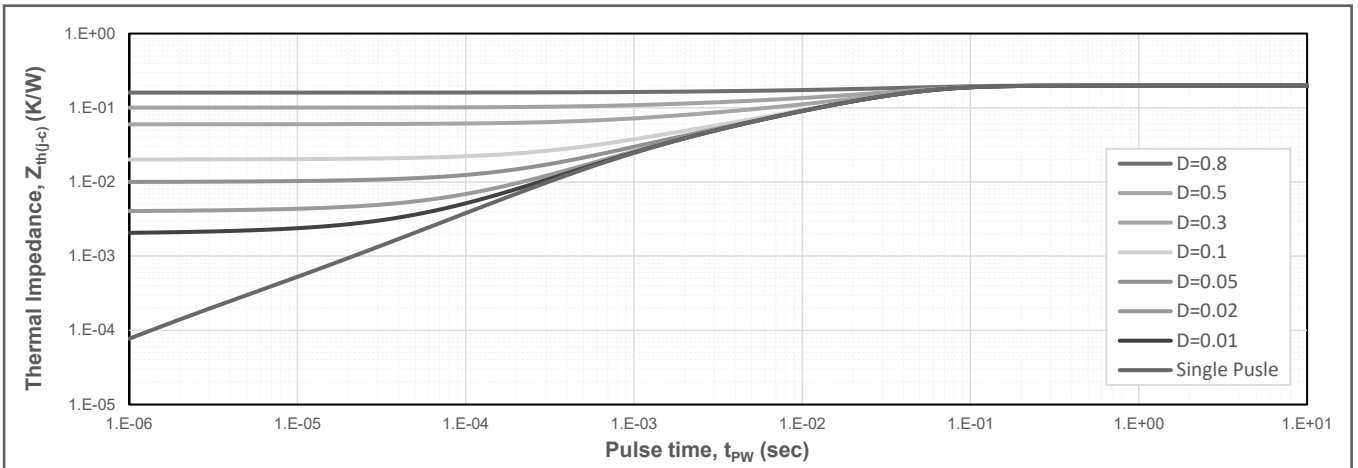
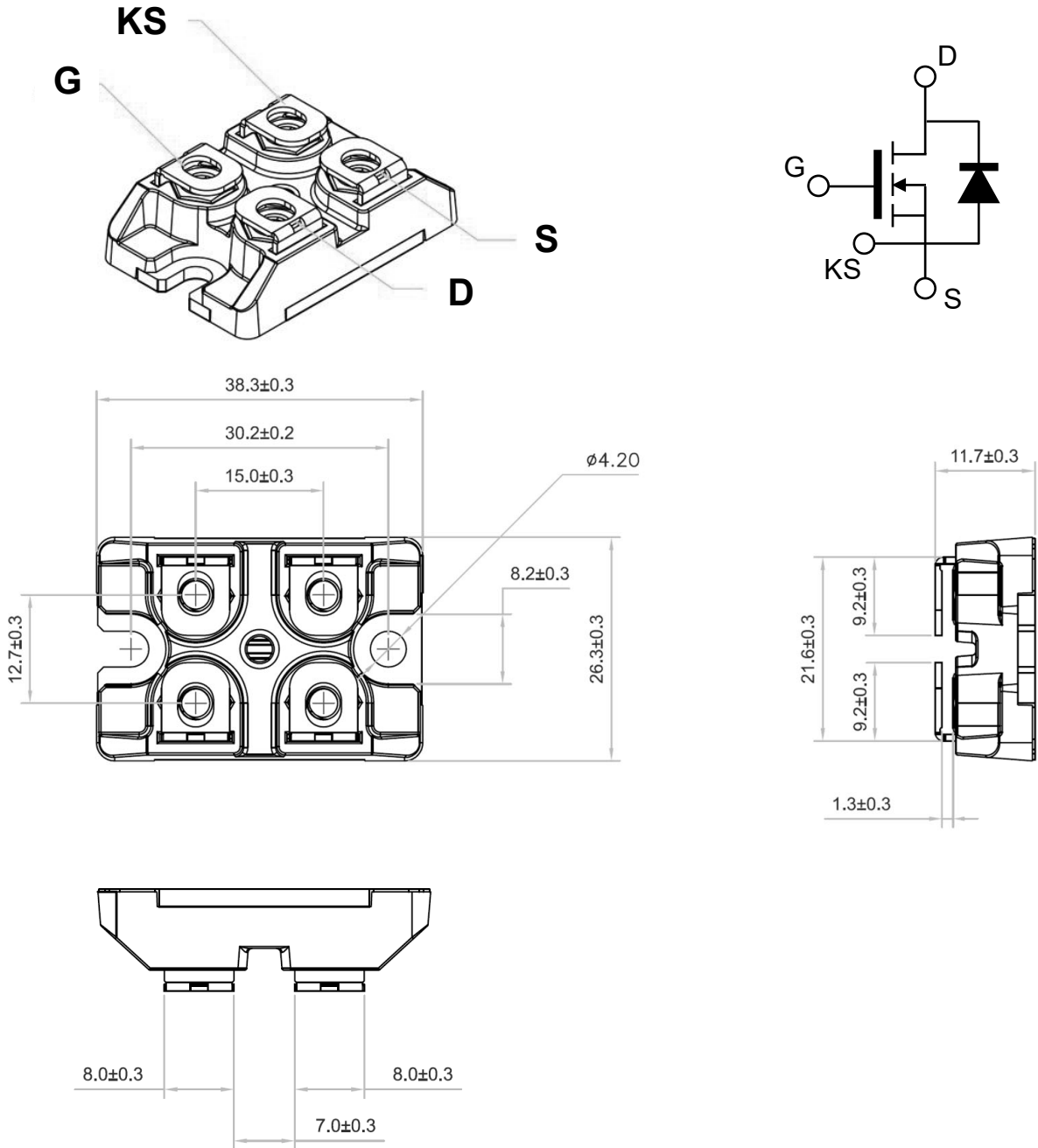

Fig.21 Transient Junction to Case Thermal Impedance



Package Dimensions



Notes

- The information provided herein is subject to change without notice.
- For other information that does not show on this datasheet, please contact us for inquiry.